

Title Goes Here!



Photography, writing, design, layout, etc.

Jakko Westerbeke <jakko@xs4all.nl>
www.xs4all.nl/~gurth/afv

Thanks to

Robert Lockie for all his help with getting the turret armour mountings right.

Simon Barnes, Philippe Bonnet, Stephen Brezinski, Robin Buckland and Matthew W. Malogorski—for pointers to models I didn't know about, for their comments about the ACE kit on the Missing Links forums, and/or for their pointers to photos of the real Enigma.

Alexey Blaschuk from ACE Models for clarifying the armour thickness on that manufacturer's kit.

Technical stuff

The photographs in this net.book were taken using an Asahi Pentax SV 35-mm SLR camera and a Fujifilm 6900Zoom digital camera, those of the former being digitised with an HP ScanJet 3400C scanner, while the computer graphics were created with POV-Ray 3.5 and the KPovModeler 0.20 and 1.0 front-ends for it. The document was laid out in Palatino Linotype, **Futura XBik BT** and CombiNumerals, using QuarkXPress 4.1 for Windows. The PDF was created with Adobe Acrobat Distiller 3.01 and worked on with Adobe Acrobat Exchange 3.0.

Copyright & distribution

This document is copyright © 2003 by Jakko Westerbeke, all rights reserved. Unless otherwise indicated, all photographs and other illustrations in this document are copyright © 2000-2003 by Jakko Westerbeke.

This document may be freely distributed, on the following conditions: that no changes or modifications are made to the document in any way; and that no profit is made off the distribution.

Other images

Photograph of Cromwell Models conversion set on page 5 taken from Cromwell Models' web site (www.xs4all.nl/~cromwell), used without permission.

ACE kit box art on page 5 taken from ACE Models web site (www.acemodel.com.ua), used without permission.

"Page-with-slide" icon taken from the GNOME 2.0 default icon set, and "WWW-globe" icon on page 5 taken from Nautilus' default icon set; see www.gnome.org for either.

T - 55 Enigma

In the 1991 Gulf War, Iraq fielded a large fleet of Russian T-55 main battle tanks, as well as their Chinese cousins, the Type 59 and 69 MBTs. A number of the former had been fitted with increased armour on the hull and turret front, apparently for use as command vehicles; these latter were soon dubbed “Enigma” T-55s. Several were captured by Coalition forces, and some were subsequently shipped to the USA, Britain and France for display.

Description

In essence, the Enigma is a standard T-55 MBT with some modifications, so detailed information about things such as layout, drive system, armament and so on will not be given here—there is plenty of information available on the T-54/55-series of tanks that will provide the basics.

 The Enigma modification basically consists of the installation of extra armour blocks on the parts of the vehicle most likely to be subject to enemy fire. Although the blocks are large and very thick, they are not solid; rather, they are hollow boxes made from steel plates welded together, with four additional plates inside, spaced several centimetres apart.

 The hull has two large, slab-like panels on the glacis plate, with holes cut into them so that the vehicle's towing hooks remain accessible. These blocks are held on the front of the hull by means of four bolts passing through them, near the corners, and by one or two bolts into vertical brackets welded to the glacis plate. A smaller block, held on by two bolts going through it, is fitted on the top of each mudguard, filling the gap between the glacis blocks and the side armour.

 This latter consists of a row of eight blocks, the front edge of which is approximately level with the hinge that holds on the front curved section of mudguard. The first block has its top sloping forward, but all the others are rectangular—though they are not of equal size, getting larger toward the back.

 The side armour is fixed to the vehicle by brackets on the rear (inside) face of each block, through which two bolts pass into a horizontal steel bar of 5 × 10 cm cross-section running along the side of the mudguard. More steel bars behind it anchor this to the hull side; these bars, of 5 × 5 cm cross-section, appear to have been welded on top of the normal mudguard. Additional braces made from steel sheet have also been fitted.

 On the turret, the armour consists of four, wedge-shaped blocks on each side of the turret. The rear three blocks on each side are the same size, but

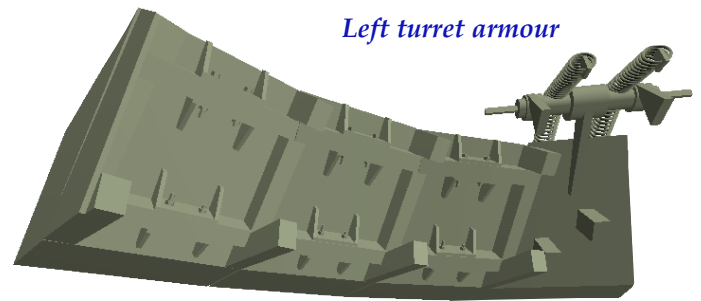

Left turret armour

the front block is larger; it is also wider on the left than on the right, but this is probably explained by the fact that the T-55's turret is asymmetrical in order to accommodate the gunner.

 The turret blocks are spaced away from the main armour by a framework made from hollow metal beams, like those used for the side armour mountings but of 5 × 7 cm cross-section.

Along the rear edge of each block is a vertical beam with spacers made from the same material to hold the mounting assembly some distance away from the turret. The lower spacer is horizontal, while the top one is fitted at 90° to the vertical bar. These spacers are simply welded to the turret, but their length varies depending on the block. The first block on the right and the second one on the left side also have such a mounting at the front edge of the block. Steel plates, cut to fit the turret curve, close the gaps between armour and turret at the front and back of each section of four blocks.

Running between the mountings are two horizontal crossbars, one near the top and one near the bottom edge of the block. The armour blocks are bolted to these by brackets similar to those used for the hullside blocks, but shallower in height. There is one bracket above and one below each of the crossbeams.

 The exception to all of the above is the left front block, which does not appear to have a shaped plate, and which is hinged at its top so that it can be lifted up for access to the driver's hatch—which would otherwise be blocked. The hinge consists of two sections welded to the turret, holding between them a third section that is welded to the block. Additionally, the left front block does not have the normal mounting brackets, but instead has two lengths of steel beam, some 15 cm long, welded to its back to space it away from the turret. Two steel coil springs attached to the top of the block, and to the turret, provide the counter-balance needed to lift the heavy piece of armour, and a locking lever is located on the inside to secure the block in the down position. A further locking pin is located on the second block, presumably for use by another crew member to lock the block down after the driver has entered his compartment.

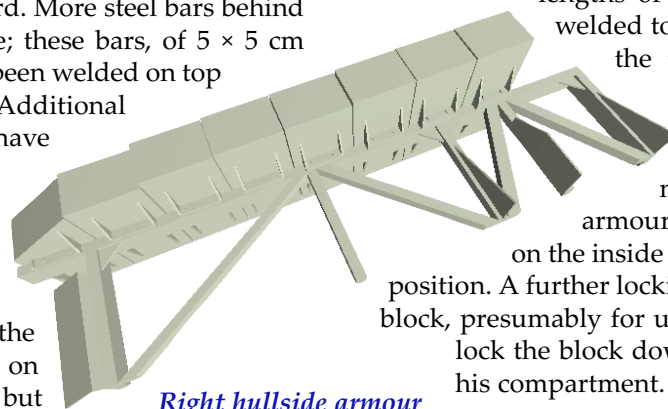

Right hullside armour

Iraqi T-55 "Enigma"

19

The right rear block is also hinged, but has no springs; the hinge itself is also of completely different design to that of the left front armour block. Furthermore, the normal spacing brackets *are* installed on this block, but so is an additional one with a gap of a few centimetres between it and the vertical bracket of the block in front. The purpose of this block's hinge is most likely so that one of the engine access hatches can be opened—the ones at the front of the engine deck are normally blocked by the turret, so on a standard T-55 that must be traversed through 90 degrees before the hatches can be opened for maintenance. With the additional armour, even when the turret is traversed to the right, the rear armour block would be in the way of one of the hatches if it were not hinged.

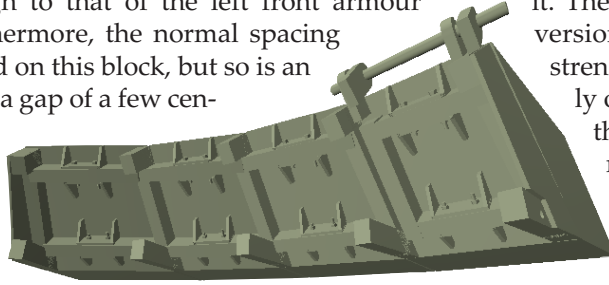

Right turret armour

23
27

Finally, the rear of the turret has two arms extending from brackets welded to the rear of the turret, with a crossbar connecting the two at the back. Four rectangular blocks of armour hang from the rear as a counterweight to the mass of the added armour on the front face, which would otherwise have made traversing the turret very difficult.

15

One of the most noticeable things about the additional armour is the construction, which appears extremely shoddy—large weld beads are visible all over, and even without measuring them, it is obvious that no two blocks are exactly the same size (except perhaps by accident rather than design). Take out a tape measure, and it becomes very clear that perfection was not foremost on the Iraqis' minds when they constructed this armour. For example, the bottoms of the side armour blocks are in line while their tops are not (leading to the conclusion that they were lined up on the ground), but the metal bar onto which the blocks are bolted slopes downward slightly from front to back on one side, and from back to front on the other; since the bar is welded onto the side of the tank's mudguard, the result is that the rear blocks sit slightly higher or lower than the front ones.

Rear turret armour

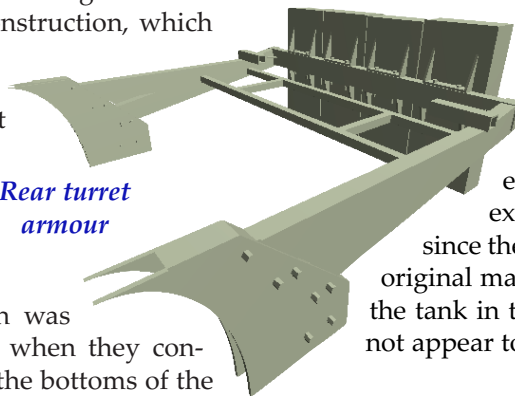

The strange thing is that this gives the tank the appearance of having armour that was hastily cobbled together out of whatever materials were available, while the details lead to another conclusion. The most obvious proof of this is in the lights: all of them, including the small station-keeping lights for night driving, have been repositioned on top of the new armour, with power cables extended to make sure they work—which is not something to be expected from a rush job.

The T-55 normally has three fuel cells on the right mudguard: one in front of the turret, and two behind it. The front one was removed for the Enigma conversion, as the mudguard it sits on had to be strengthened. The long, narrow bin that is normally on the left-hand mudguard was put in roughly the fuel tank's place, however. An oil tank is normally located between the fuel tanks, but this was moved to be on top of the exhaust, on the left mudguard. Finally, the rectangular bin that is at the front of the left mudguard was placed on top of the struts that hold the turret rear armour/counter-balance.

A point of note is that some tanks, such as the one pictured on the following pages, has a Russian-style loader's hatch with machine gun mount. Some other pictures of uparmoured T-55s, however, show vehicles that were fitted with Iraqi-designed loader's hatches with machine gun mounts.

Colours & markings

Like most other Iraqi vehicles, the Enigma tanks were painted in a sand colour, to blend in with the desert terrain. Although notorious for having worn paint that chipped off all over the vehicle, judging by photographs taken in the 1991 Gulf War, the paint jobs of Enigma T-55s were in fairly good condition, certainly compared to a lot of other Iraqi equipment.

The Enigma tanks were apparently used mainly (or perhaps exclusively) as command tanks, though at which level (company, battalion, etc.) is not known. As most captured examples seem to have been repainted since their arrival at the various museums, any original markings on them have been obliterated; the tank in this net.book an exception, but it does not appear to have had any Iraqi markings at all.

The photos

The tank pictured in this net.book is in the collection of the Tank Museum in Bovington Camp, United Kingdom. According to reports on the Modern discussion forum at Missing Links, the basic tank appears to be a Czechoslovakian- or Polish-built vehicle.

This specific tank also appears in a few photographs in the Concord book, *After the Storm: Iraqi Wrecks & Fortifications*, by Eric Micheletti, easily recognisable by the large "Jeanne" spray-painted on the side armour. In this book, it is captioned as being on the highway from Kuwait City to Umm Qasr, and as belonging to the Iraqi 14th Infantry Division. Some small photographs of it are also in *Sword in the Sand: U.S. Marines in the Gulf War* by



Tony Engelhart and Pat Foran, though in this it is much less recognisable because the most obvious graffiti (such as the "Jeanne + Chris"

and "91 Calvin & Hobbs" tags) either cannot be seen in the pictures, or they were taken before most of the graffiti was applied. Other graffiti in those pictures, however, seems to indicate the vehicle was captured by the US Marine Corps.

Some things these books show quite clearly is that the tank had rammed the rear of another (non-uparmoured) T-55 in front of it, and that somehow the two fuel tanks on the right rear mudguard had fallen off the uparmoured tank. Interestingly, these photos also seem to indicate one serviceman went home with a souvenir Enigma armour block in his pack: the earliest photos (where no graffiti has yet been sprayed onto the tank) show the left front block in place, whereas in the photos *with* graffiti, it has mysteriously disappeared ...



Interestingly, over the years "Jeanne" seems to have *lost* much of the initial graffiti, though it is obvious it was still in its original paint in 2002.

Modelling the Enigma

Naturally, the main requirement for building a model of this tank is a T-55 kit; although these are available from at least four different manufacturers, really the only one worth buying in 1:35th scale is the Tamiya kit. The various kits by Esci, Skif and Trumpeter all have numerous problems in both details and general accuracy that make them poor choices even if they are much cheaper than the excellent Tamiya kit.



Similarly, a few different Enigma conversion kits are also available, including from AEF Designs, Cromwell Models and Verlinden. The latter was originally made for the Esci kit, but has been re-released (with few or no changes) as being suitable for the Tamiya kit as well; unfortunately it suffers from lots of dimensional inaccuracies.

The Cromwell set, number CA131, was made for the Tamiya kit, and is much more accurate than the



Cromwell Models conversion kit installed on Tamiya model

Verlinden one; apparently, it was based on the same vehicle pictured in this net.book. Not much is known at this time about the AEF Designs set except its title, KM-14 *Iraqi "Command" tank*, while Accurate Armour have also announced an Enigma conversion, including decals, for release in 2004 as conversion kit C084.

In 1:72nd scale, ACE produces a T-55 Enigma as a complete plastic kit, no. 72152. The general consensus among small-scale modellers seems to be that the basic kit is a bit rough and can use a bit of work, but the advantage is that there is no need to scratchbuild, or use a conversion set for the armour. However, the side armour is 1 mm too thin (to prevent moulding problems, according to ACE), but this is easy to solve by adding some plastic card to the backs of the side armour panels.



ACE kit box art

Another small-scale Enigma, this time in 1:76th scale, is available from Cromwell Models in their *Combat Ready* range as kit CR2007. As this model was brand-new when this net.book was being put together, no pictures or reviews of it are yet available.

Most, if not all, Iraqi T-55-series MBTs seem to have been fitted with the older style of track, as provided in Tamiya's kit, not the T-72 track that was retrofitted to most T-55s and T-62s in Warsaw Pact countries during the 1980s.

Armour dimensions

The illustrations on the following pages show the armour blocks and their mountings, with dimensions taken directly from the vehicle on display at the Tank Museum in Bovington. Keep in mind that, given the apparent lack of precision in the construction of the extra armour, it is likely that no two vehicles were exactly the same. Therefore, if your aim is to build an accurate model, only use these drawings in conjunction with other references.



Accurate Armour: www.accurate-armour.com

AEF Designs: www.aefdesigns.com

Cromwell Models: www.xs4all.nl/~cromwell

Verlinden: www.verlinden-productions.com

HULL ARMOUR

Glacis armour

Dimensions (cm)
height width wepth

left 1	23/44*	73	12
2	93/113*	70	12.5
3	103/123*	100	12.5
right 4	23.5/44.5*	72	12.5

Right-side armour

Dimensions (cm)
height width depth

front 1	40/56*	31	21.5
2	57.5	31	21.5
3	61	31	21.5
4	62	31	21.5
5	64	31.5	21.5
6	64	31	21.5
7	64	31	22
rear 8	64.5	31	22

Left-side armour

Dimensions (cm)
height width depth

rear 8	64.5	31	21.5
7	64.5	31	22
6	64.5	31.5	22
5	63	31	21.5
4	62	31	21
3	60	31	21.5
2	57	31	21.5
front 1	?/56**	31	?**

* The first dimension is for one side of the block, the second for the other side.

** As this block is missing on the tank that was measured, its size could only be determined from the rusted area, which is 56 cm high. The height of the other side of the block is unknown, but was probably some 40 cm; its depth is also unknown for the same reason, but will have been about 21 cm. (This is also why the block is drawn semi-transparently in the illustration.)

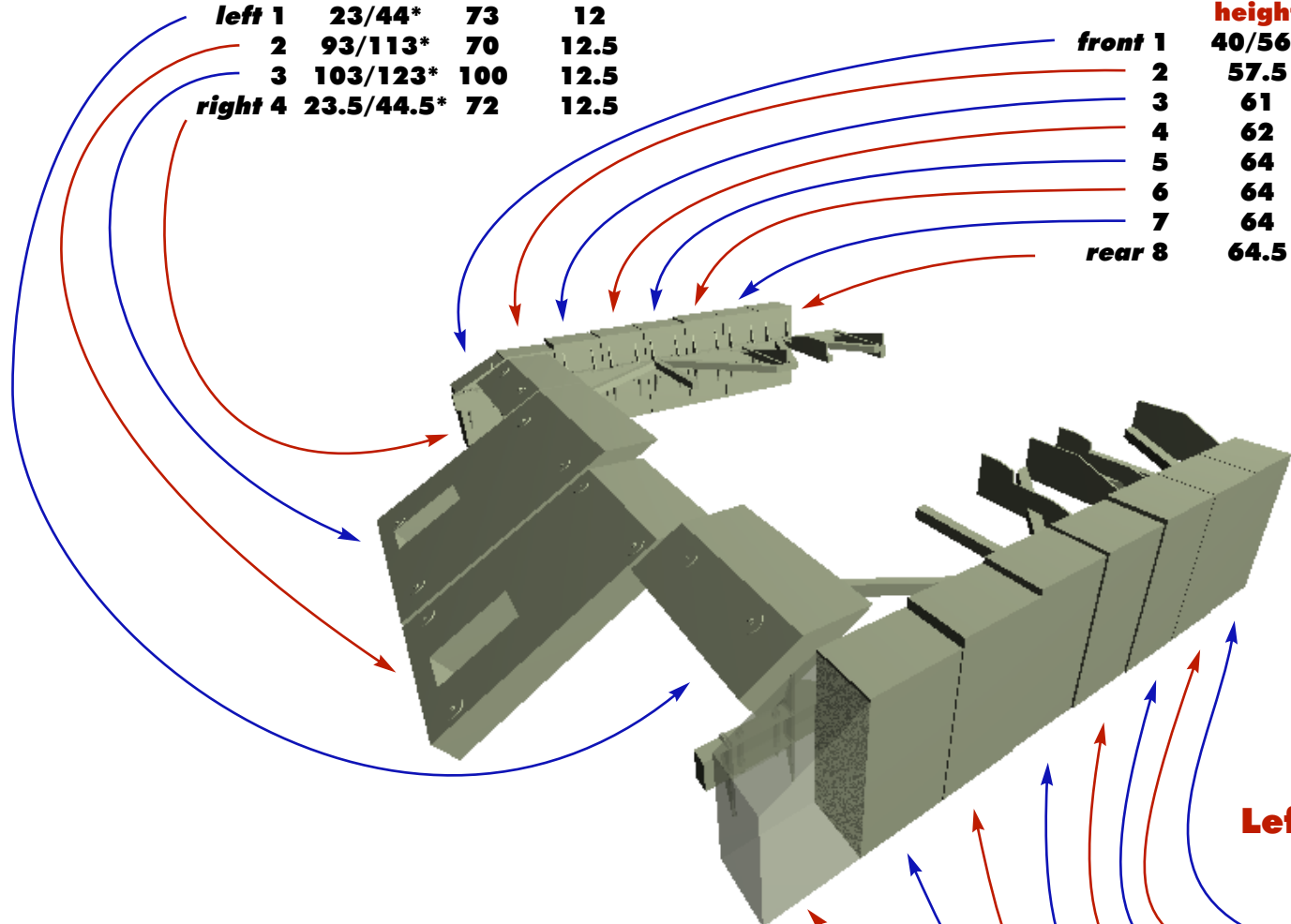

d i m e n s i o n s

Left side (top view)

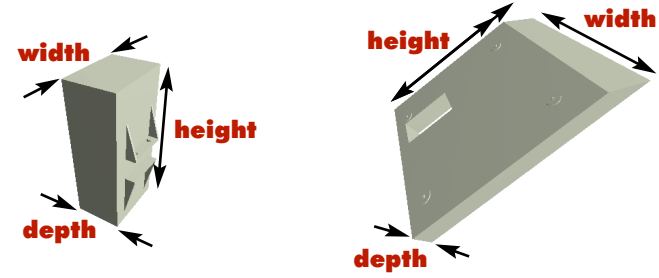
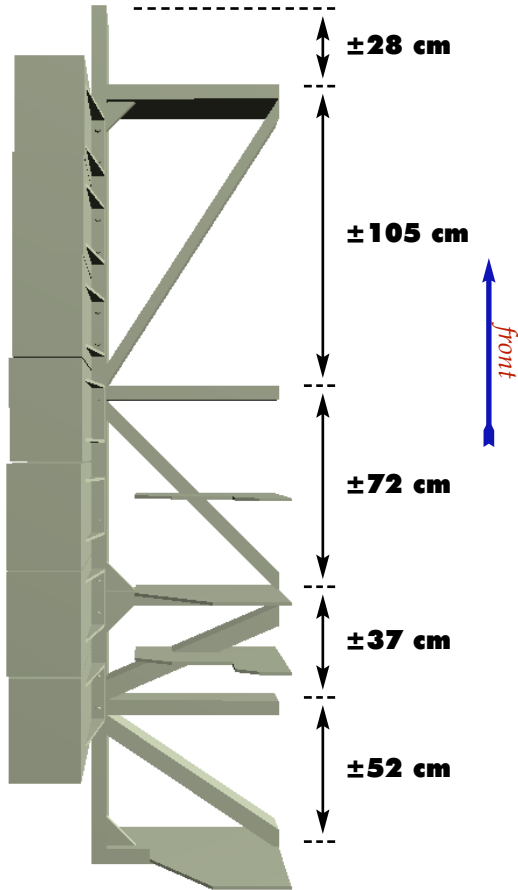

Right side (inside view)

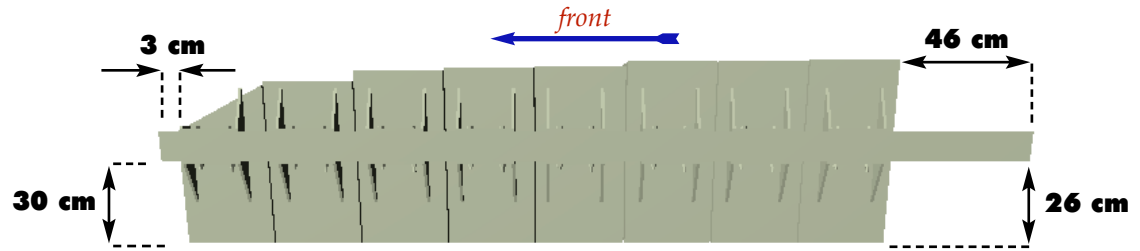

Left side (inside view)

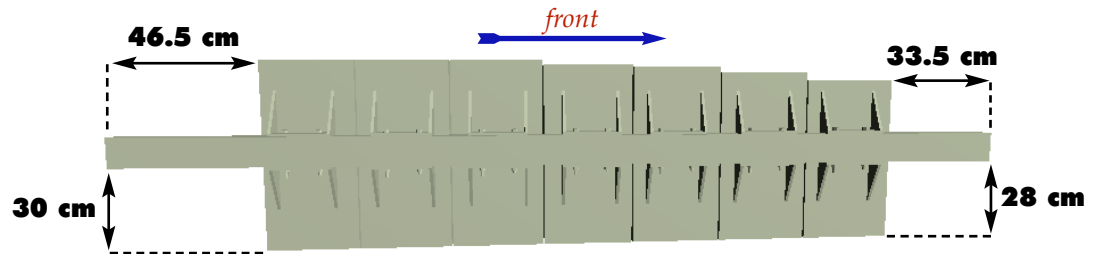

Dimensions in this drawing are approximate, from the front of each beam to the front of the next; the right is (for practical purposes) identical. The diagonals are not included in the measurements.

T U R R E T A R M O U R

Turret right armour

	Dimensions (cm)					
	front width	top width	centre width	bottom depth	bottom width	back width
front 1	41	48	?	38	66.5	58
2	41	48	50	?	56	?
3	41.5	48	50	?	56	?
rear 4	41	49	50	37	56	56.5

Turret rear armour

	Dimensions (cm)		
	height	width	depth
right 1	72	31.5	12.5
2	72	31	12.5
3	71.5	31	12.5
left 4	72.5	31.5	12.5

Turret left armour

	Dimensions (cm)					
	front width	top width	centre width	bottom depth	bottom width	back width
rear 4	42	48.5	50	37.5	56/47*	55.5
3	40.5	49	49.5	?	56.5/?*	?
2	41.5	49	50	?	56/?*	?
front 1	41	50	50	36	71/49*	59

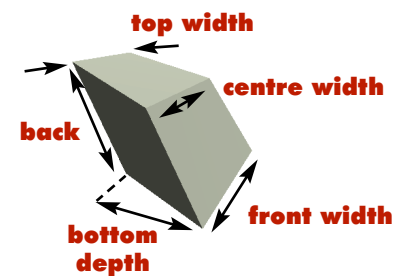

* The first dimension is for the bottom width at the front the block, the second for the width at the back (the side against the turret).

Left side (bottom view, with armour blocks)

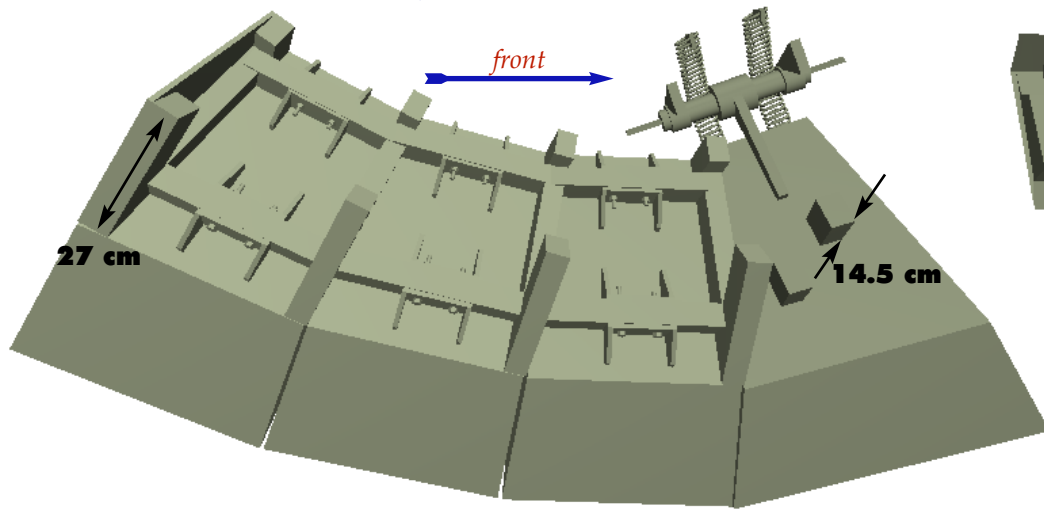

Right side (inside view)

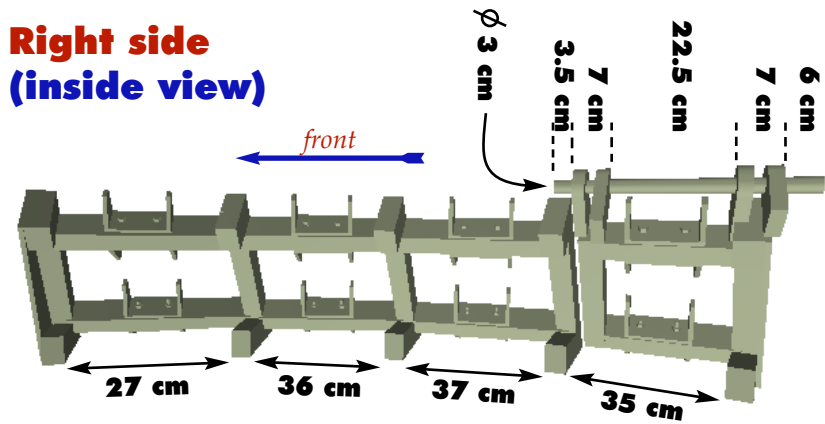

Left side (inside view)

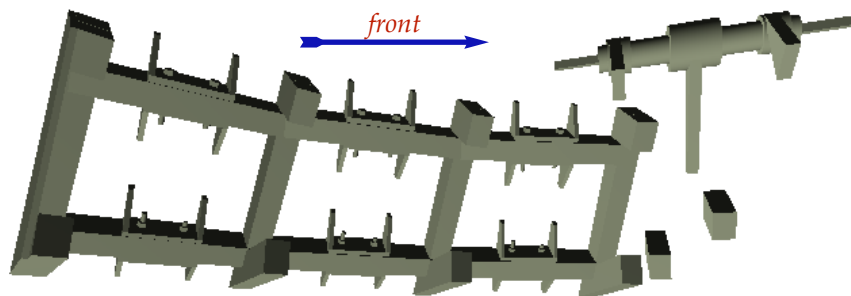

Right side (bottom view)

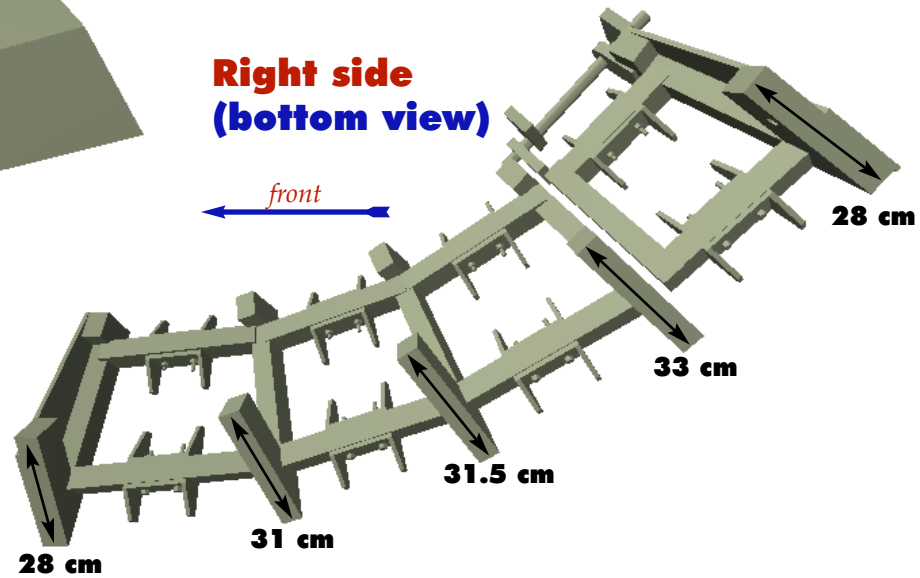

Rear strut & mount

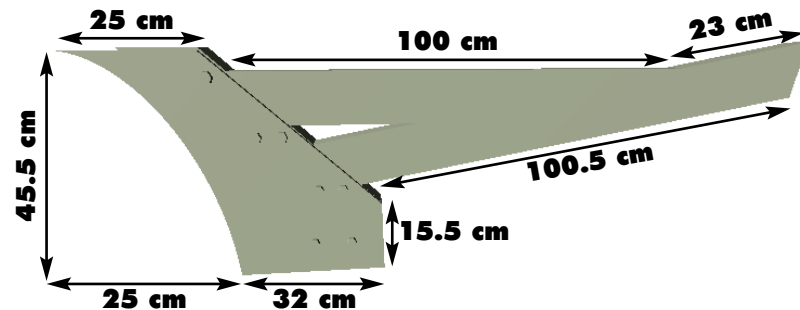

Unfortunately, most dimensions for the left-side framework are not available. Beams spacings in the inside right view are measured *between* the beams—they do not include the beam thickness of 5 cm. Although the beams are shown as solid in these illustrations, they are hollow on the real tank. Also, though the end plates are shown with a straight edge, they are really cut into a curve to fit the turret shape.

Left front view

This photo shows most of the extra armour added to this T-55 by the Iraqi army; only the large blocks on the glacis and those on the back of the turret are not visible.

The turret armour over the driver's hatch is in the raised position, giving a view of the bottom face, which has been cut open to show the way the armour is constructed.

Note the rusted areas where the front-most block of the left hull-side armour used to be. This was already missing and rusted when photos of this tank were taken soon after it was abandoned by the Iraqis. The most likely explanation is that the blocks were installed on the brackets without being painted, after which everything got a coat of paint—which would not have been able to get far down between the blocks, leading to rusting.

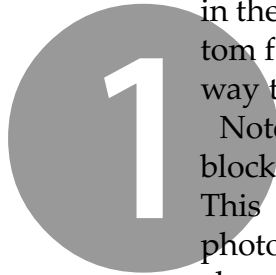

Glacis armour

The additional armour plates on the tank's hull front are much larger than those on the hull sides, and smaller blocks are carried on the mudguards to either side of the top of the glacis.

Note the damaged headlights, the cause of which was probably the collision with another T-55 that this tank suffered during the Iraqi retreat from Kuwait. When the headlights were relocated, a tube for their power cable was added, running approximately down the centre of the right-hand armour panel.



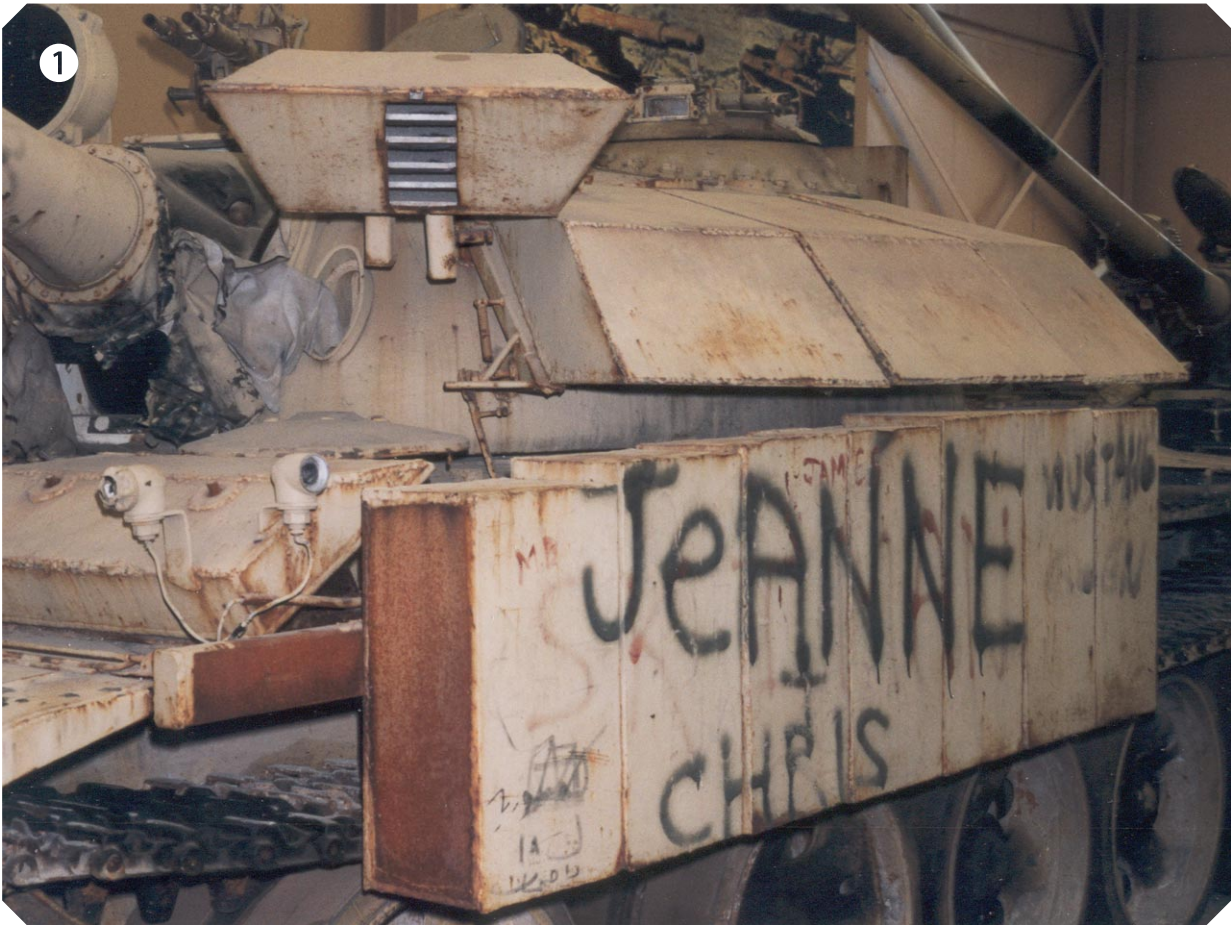

Left side glacis armour

One of the two armour panels on the glacis, showing to advantage the large opening that had to be left in them in order to allow the tank's towing lugs to remain accessible.

The panel is held in place by four bolts that go through the discs near the corners, and also by a single triangular lug welded onto the glacis near its front edge; in this photo, it is hidden by the museum's information sign visible at the bottom of the photograph.

The other panel is wider, and held up by two lugs in addition to the bolts. Just visible in this photo is also that the left-hand panel is also a little lower than the right one, so as not to obscure the view from the driver's periscopes.



Hull front

A view of the area around the driver's hatch (the flat object at the right of the photo). In the foreground on the left is the top of the left mudguard armour block, while in the background is the right-hand glacis armour panel. The left-hand one is barely visible between the two because of its reduced height.

The mudguard armour block is held on by two bolts that connect it to an angle iron bracket on the front mudguard. At least one Enigma had some kind of hinge arrangement on the back of this armour block: one small, steel plate with a hole in it welded to the rear face of the block, and a similar one to the mudguard bracket, with a pin or bolt put through the holes make a hinge. The tank pictured here, though, has no such thing.

By the way, in the foreground, the rectangular object to which the hose is connected, is the tank for the driver's periscope washers.

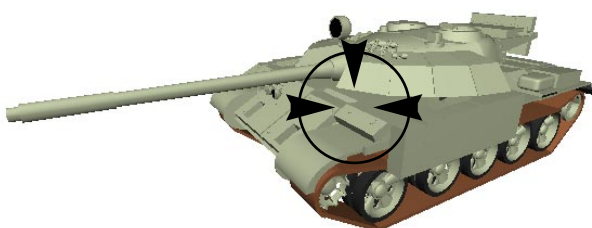

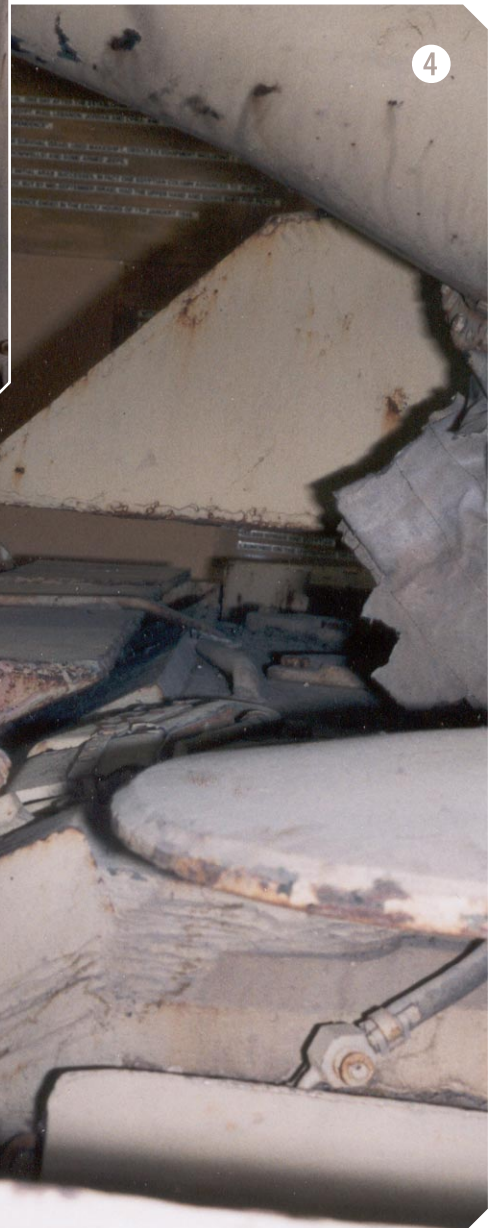

Right hull front

These are the standard Russian night driving lights, which on a T-55 are normally located at the upper corners of the hull. When the Iraqi army upgraded this tank, the lights were repositioned on the outer corner of the hull front armour panels. The front-facing light is missing the forward part that holds the white lens, however, and is also bent backward—probably because of the collision with another tank before its capture.

This photo also gives a good view of the bracket on the back of the front-most armour block on the hull side, which is much lower than the brackets of the other blocks—for obvious reasons.

The long, narrow box visible at the back of the photo is the one normally fitted in front of the exhaust on the left mudguard.

5

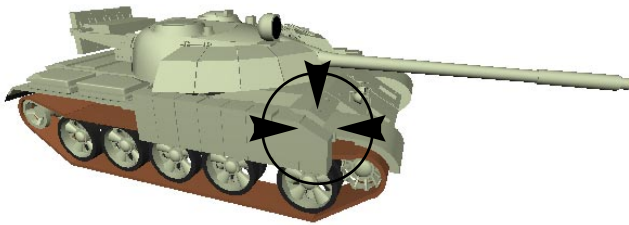

Right hull side armour

This photo takes in (just) all eight blocks that make up the hull-side armour. The top of the front block is sloped toward the front of the tank, at about the same angle as the hull font. The forward block is missing on the other side of the vehicle, but would have been similar to this one.

6

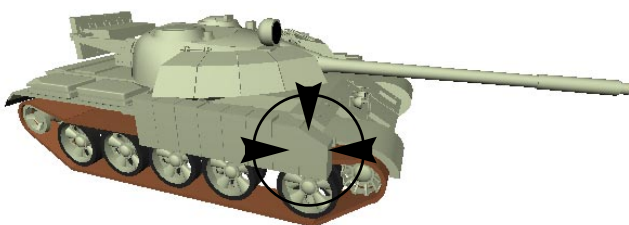



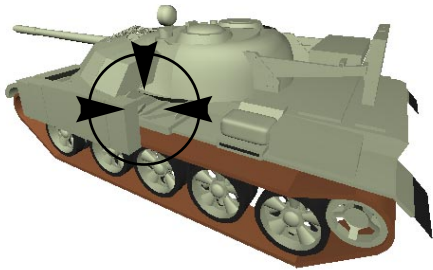

Left armour mounting

By the looks of it, the Iraqis installed a framework of metal tubing on top of the existing mudguard, in order to hold up the longitudinal bar onto which the armour blocks are bolted. This bar is 5 × 10 cm in cross-section, and runs back further than the armour itself—far enough, in fact, for the installation of another block and a half, though since no holes for their bolts are visible, it looks like this was not the intention.

At the back of the photo, the periscope washer tank is visible (the rectangular item with the filler cap on top). This is not present on the otherwise excellent Tamiya kit, and its shape is normally hard to see because a bin is usually installed to the left of it.

Armour mounting

Seen from the opposite side, this is again the left mudguard and the armour mounting points on it. Each armour block has two U-brackets welded onto it, one as visible in the photo and the other upside-down, with the mounting bar sitting between them. Two bolts go through holes in the brackets, and through the bar, to fix the blocks to the bar.





Right front

A view of most of the right front corner of the T-55 Enigma, giving a good view of both the hull front and right turret armour. The latter consists of four wedge-shaped blocks arranged in a quarter circle, providing good protection to the turret face, although there is a fairly large gap between the hull and turret armour that an incoming round could quite easily get into.

Unlike many other Iraqi T-55s, this one does not have a curved steel plate around the searchlight, though there are photos of Enigmas that do have this feature; standardisation seems to have been near the bottom of the Iraqi army's "to do" list. Note the shine of the searchlight's infrared filter: enough to reflect one of the light fixtures of the museum hall.

9

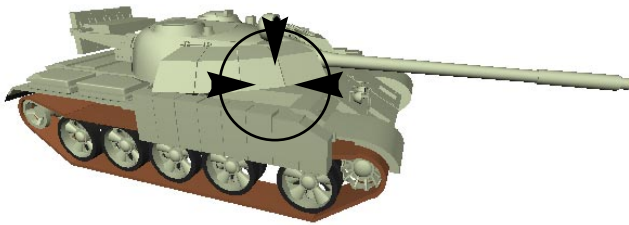

Right rear turret armour

The side of the rear right armour block, which shows the blocks' wedge shape to advantage. Also visible is the hinge that, on the right side of the turret, is only on this block; its most likely function is to allow the engine deck hatches to be opened (on the T-55, the turret needs to be traversed before this can be done, but without the hinge, on the Enigma the extra armour would get in the way when the turret is turned far enough to clear the hatches).

Although the armour blocks are held some distance away from the turret main armour by metal struts, plates have been welded on at the ends to close the gaps this would otherwise leave. It appears the plate on this side is attached to the struts, and so would be lifted up with the hinged block.

The hole in the lower strut is for a locking pin, but only the weld of its bracket on the turret remains on this particular tank.

10

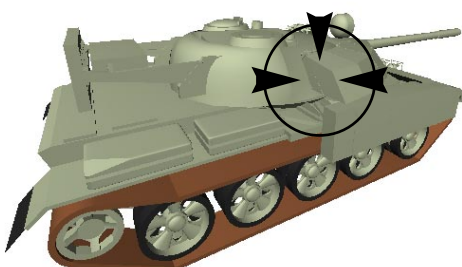



Right front turret armour

This is the right turret armour seen from the front, again showing the wedge shape as well as the plate welded between the extra armour and turret face. The armour blocks do not extend all the way to the gun because the oval opening for the coaxial machine gun would otherwise be blocked.

The front block is wider than the other three on the right side of the turret, although this is not really obvious, especially not from this angle.

This picture also gives a good view of the height difference between the left and right glacis armour panels.

11



Left front turret armour

The front block on the left side is also hinged, and is displayed in the up position on the Bovington exhibit. Unlike the rear right block, though, this one is provided with two counter-balance springs (one is just visible at the top of the photo) because the driver will need to lift the block every time he needs to get into or out of the tank. The block is locked down by a spring-equipped latch, but as can be seen here, the lower end of the spring has come off on this vehicle.

Note the way the struts for the remaining three armour blocks fit, and the much simpler way the raised block is spaced from the turret by nothing more than two lengths of square tube welded on. Also, no plate has been welded to the block or the turret on this side.

12



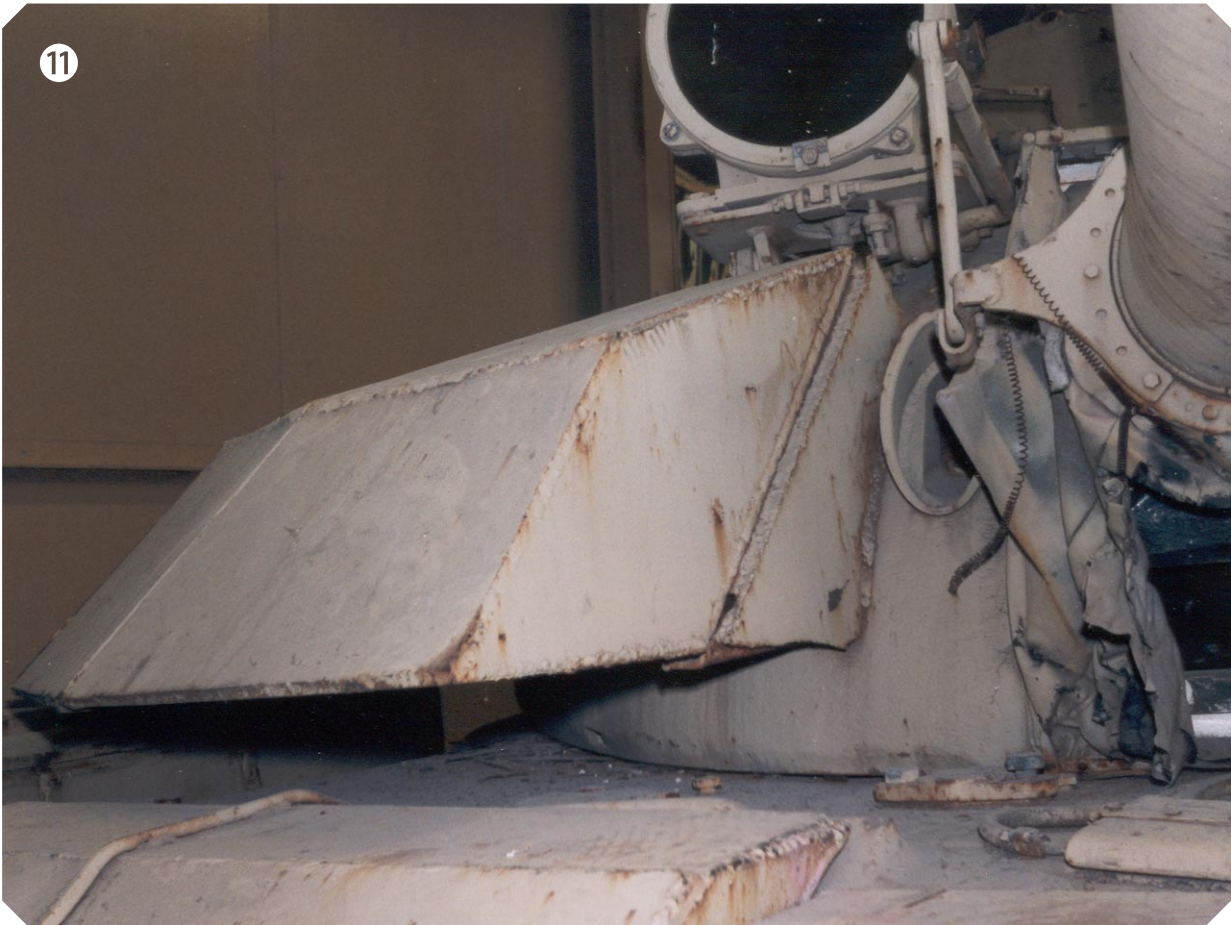

Left rear turret armour

13

The fourth block on the left turret side does have a plate to fill the gap with the turret. The rear three blocks on the left are (almost) identical in size to the rear three on the right, but the left front and right front blocks are different, both from the other six and from each other. Also, the left rear block is not hinged, unlike the one at the right.

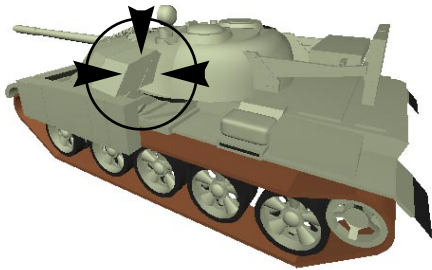

Rear armour struts (1)

14

The panels that make up the rear armour are held about 1½ meters away from the turret by two struts that are well-secured into brackets welded onto the turret rear wall. The struts themselves are made up of two metal tubes (once more 5 × 10 cm in cross-section) in a flat Y-shape, with a steel plate cut to this same profile welded on at the outside.

Some Enigmas have three triangular pieces of steel as braces on the inside of the joint between the bracket and the turret rear armour (one at about an angle of about 30° to the horizontal at the top, a horizontal one about halfway down, and another horizontal one all the way at the bottom). This tank, though, has no trace of these at all.

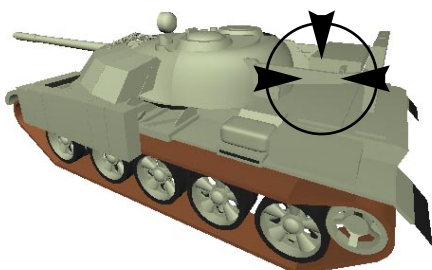



Rear armour struts (2)

Another view of the struts holding the rear armour, which also serves as a counter-balance. This photo shows more details of the turret brackets, which are of substantial construction, though they are not solid—they consist of two plates spaced far enough apart for the struts to go between them. Seven large bolts as well as some crude welds keep everything together.

15

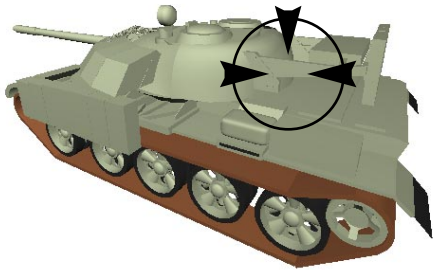

Turret rear armour

The back of the rear turret armour, with some graffiti still in place. Each of the four blocks is both taller and thinner than those on the hull side; whether they are true armour blocks, or only serve as counterweights for the turret armour is not entirely clear.

A grab or stowage rail has also been added to the rear of the turret, centrally and much lower down than standard T-55 turret rails are fitted—the additional armour is in the way of their normal locations.

16

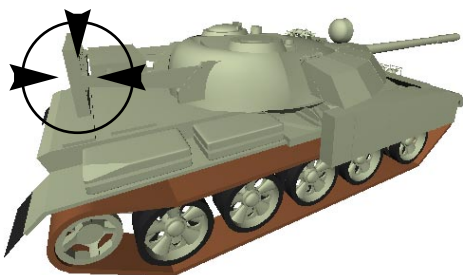

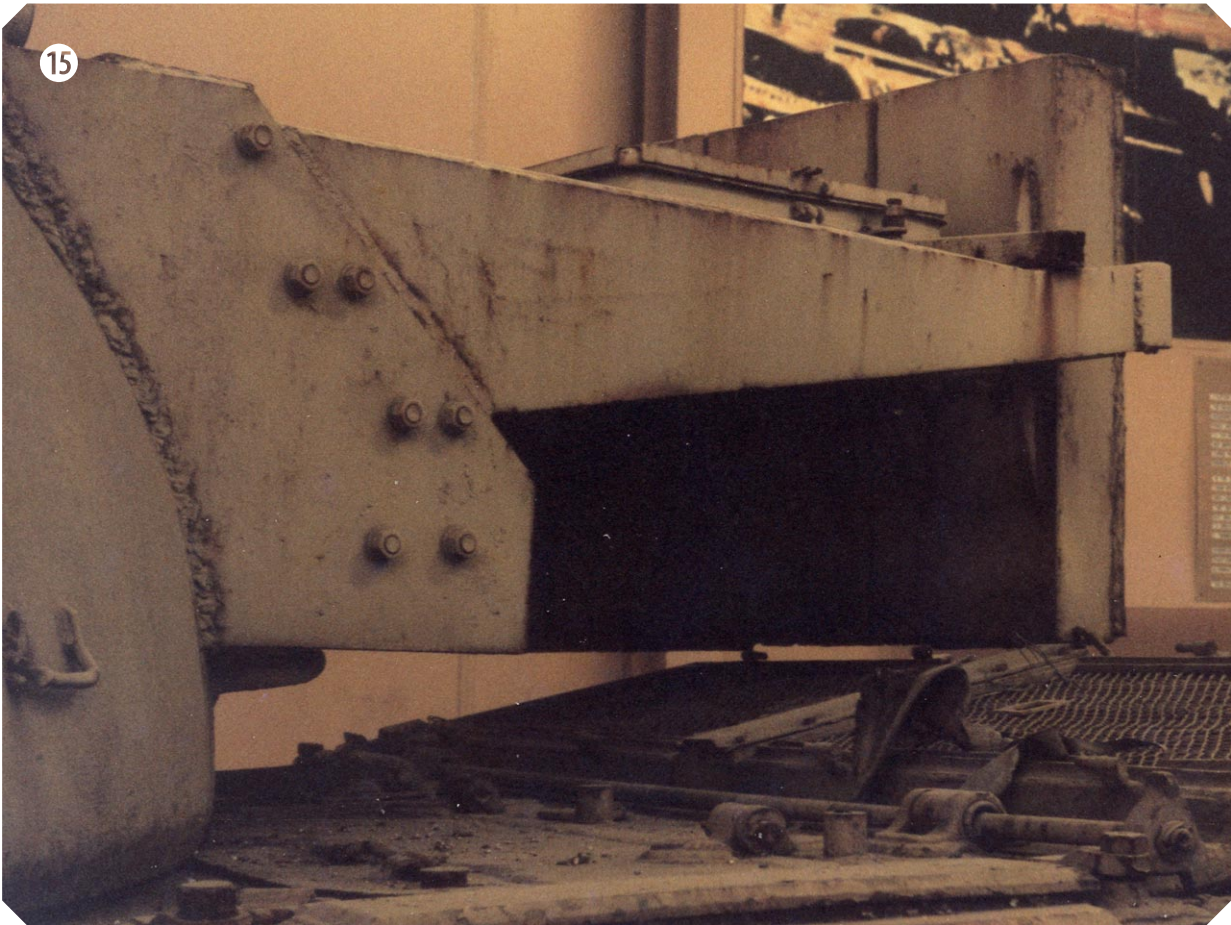

Rear armour underside

17

The underside of the armour on the rear of the turret, showing that the rear panels are held on with the same kind of brackets that the hull-side armour is mounted on. Crossbeams run between the struts, and the bin that is normally located on the T-55's left front fender has been placed on top of them.

